

INSIGNIA™

QUICK SETUP GUIDE

32" LED TV
NS-32D200NA14

Thank you
for purchasing this state-of-the-art Insignia television. We hope you enjoy the quality and reliability of this television for years to come.

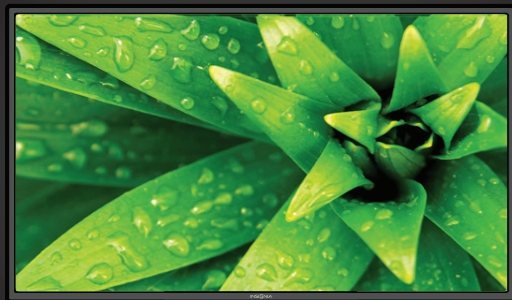

1 START HERE

How do I attach the stand to my TV? (not for wall mounting)

You'll need: A Phillips screwdriver and a soft surface to lay the TV on.

- A** Carefully place your TV face-down on a cushioned, clean surface to protect the screen from damages and scratches.
- B** Align the TV stand with the bottom of the TV.
- C** Secure the stand to the TV with the three provided screws.

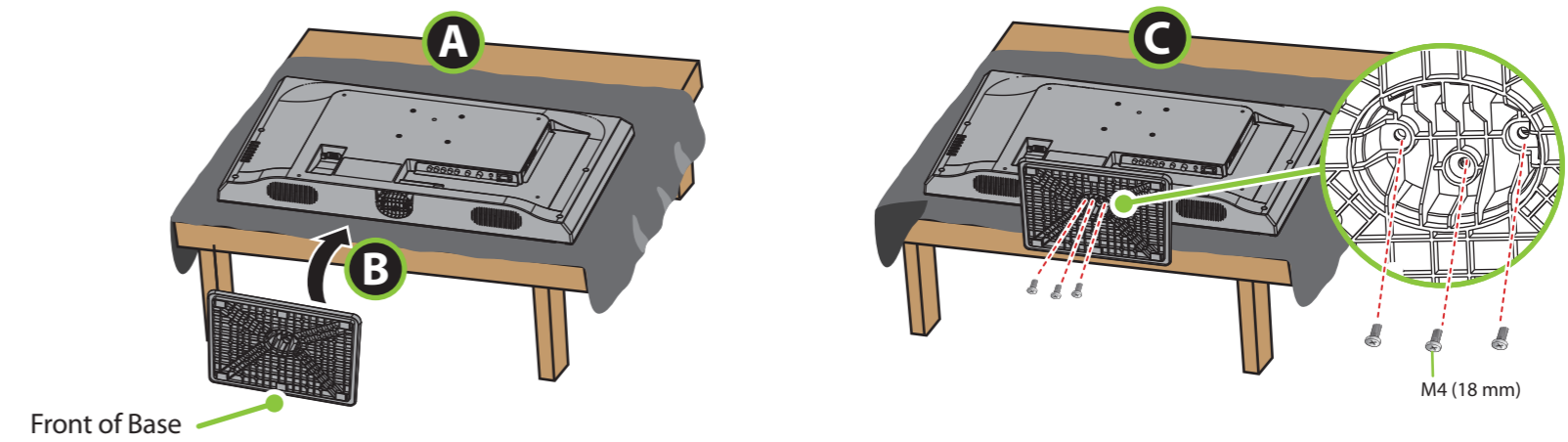

- OR -

How do I prepare my TV for wall mounting? (not for use with a TV stand)

- A** Carefully place your TV face-down on a cushioned, clean surface to protect the screen from damages and scratches.
- B** Locate the mounting screw holes on the back of your TV. See the instructions that came with the wall-mount bracket for information about how to correctly hang your TV.

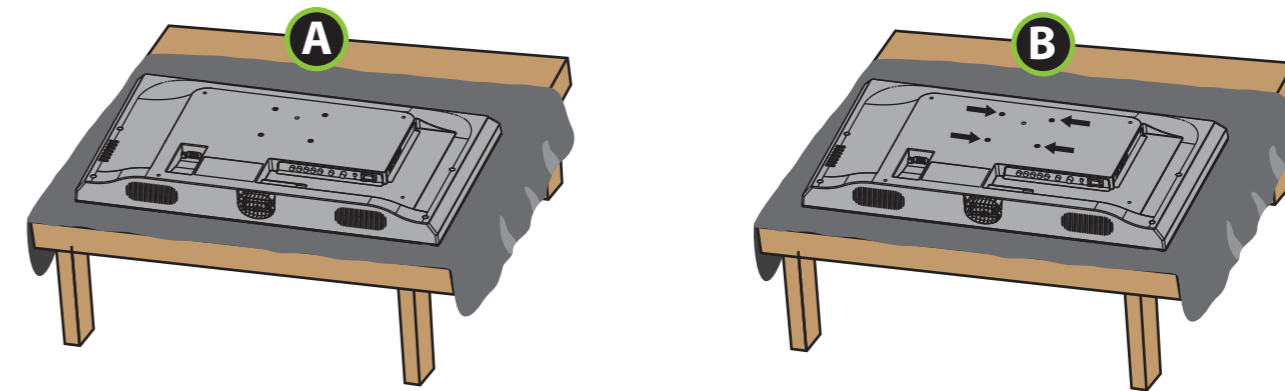

STOP!
Do not plug your power cord in until all other devices have been connected.

Included accessories

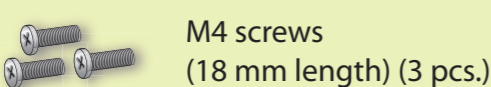
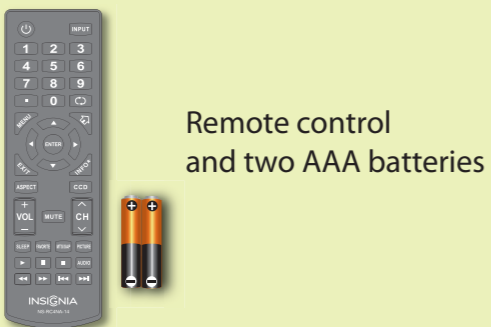
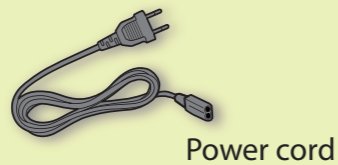

Which cables do you have?

Your TV has several different jacks for connecting devices. For the best video quality, use the best available connection. Use the cables that came with your devices.

VIDEO QUALITY	JACK TYPE	CABLE CONNECTOR
BEST	HDMI video/audio	
BETTER	Component video and analog audio	
GOOD	Composite video and analog audio	
GOOD	Coaxial video/audio	

Note: You can use the **HDMI 1/ARC/DVI** jack to connect a DVI device to your TV. Attach an HDMI-to-DVI adapter to the end of the HDMI cable. The adapter connects to the DVI device's jack. See your online *User Guide* for more information about different types of HDMI (ARC, DVI, MHL).

Features

Front view

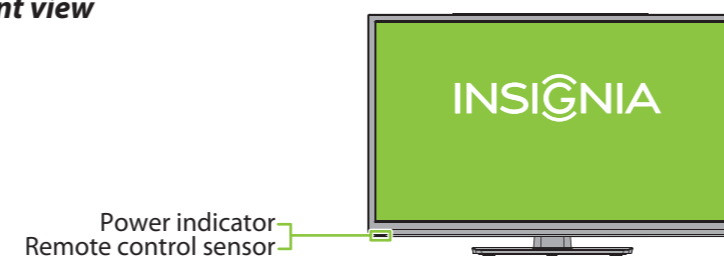

Back view

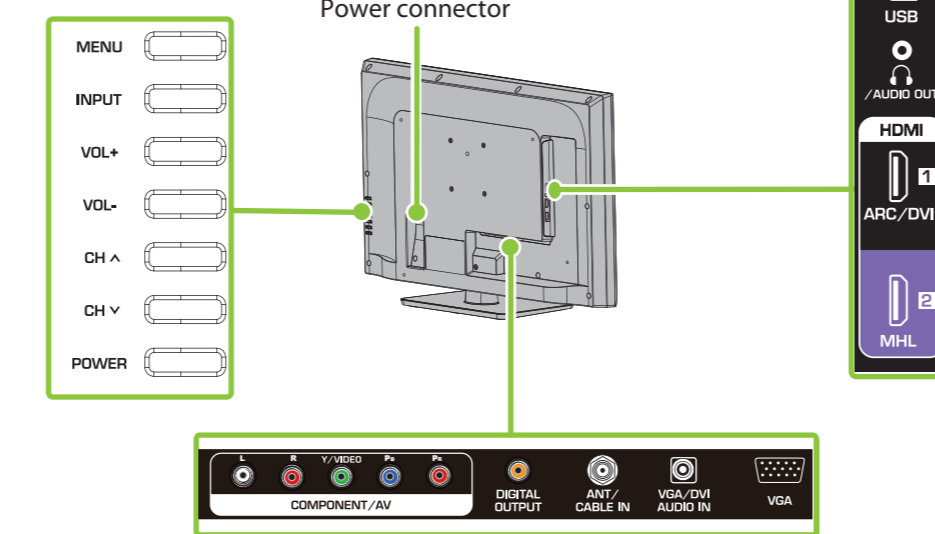

Note: Images do not necessarily represent the exact design of your television.

2 MAKING CONNECTIONS

How do I watch TV (cable or satellite receiver) or connect a device such as a DVD or Blu-ray Disc player, game station, MHL-enabled device, Roku Streaming Stick, or camcorder?

Using an HDMI cable (BEST)

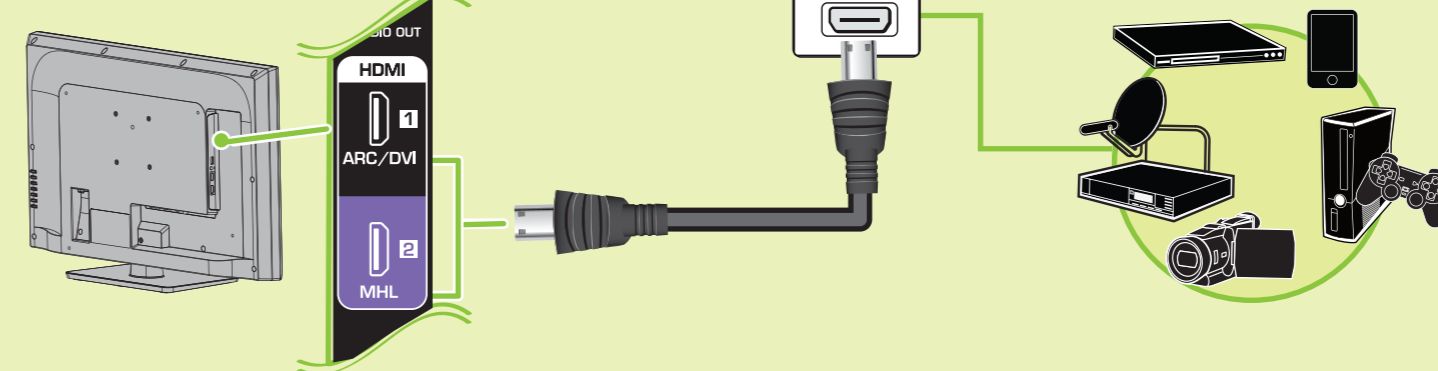

Using component cables (BETTER)

- OR -

Using an AV cable (GOOD)

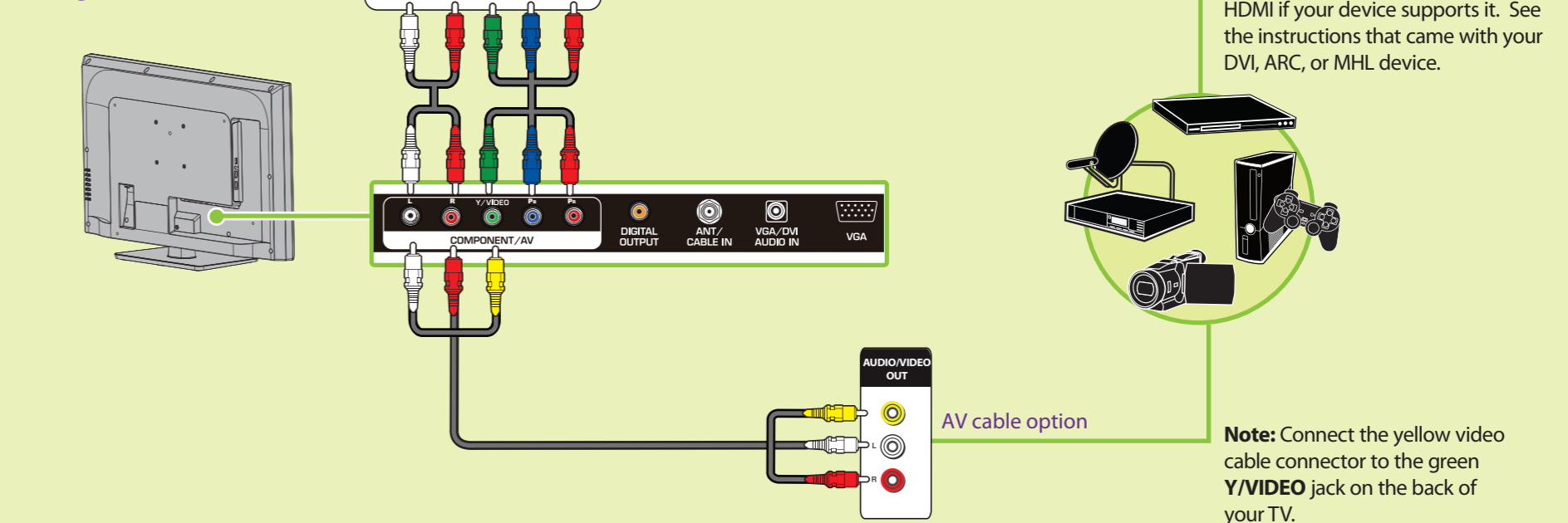

How do I connect my TV to an antenna or cable wall jack?

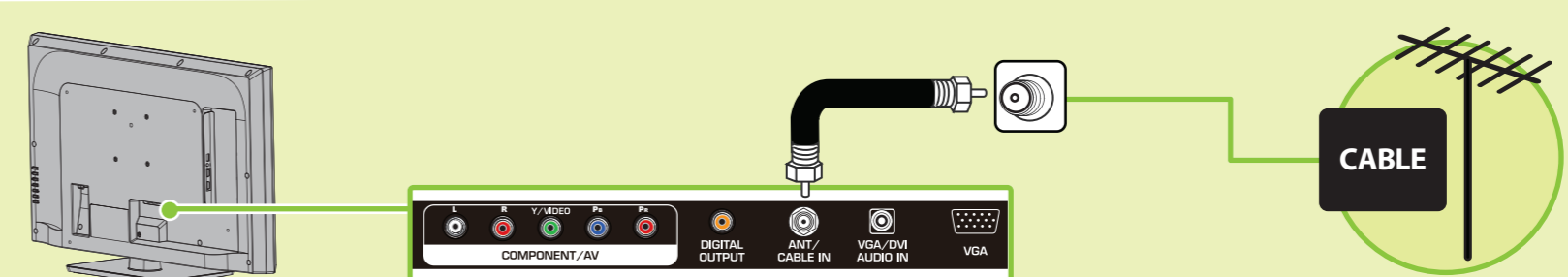

OVER

3 CONNECTING AUDIO DEVICES

How do I connect my TV to external speakers?

Using digital audio

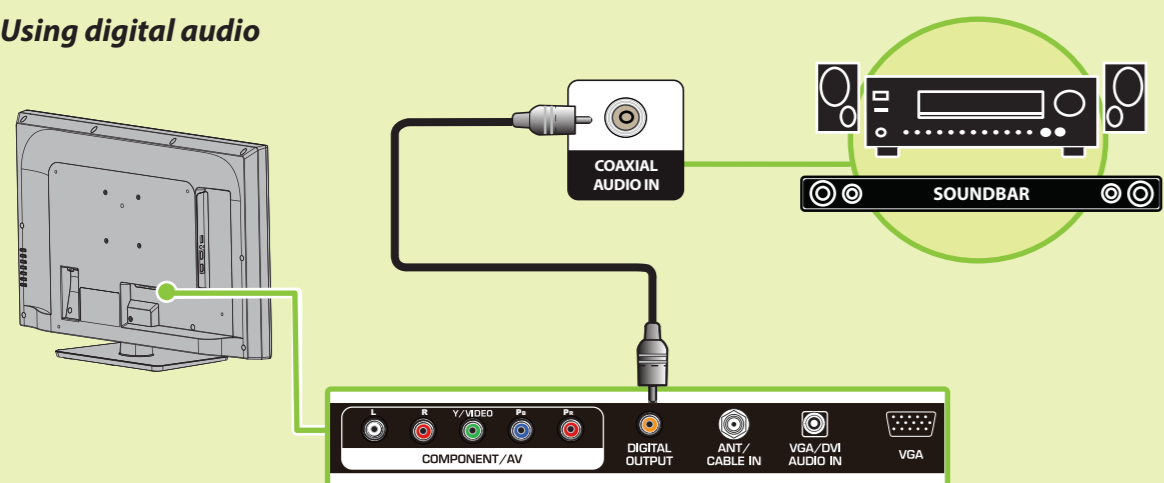

Note: Refer to the instructions that came with your speakers for more information.

- OR -

Using analog audio

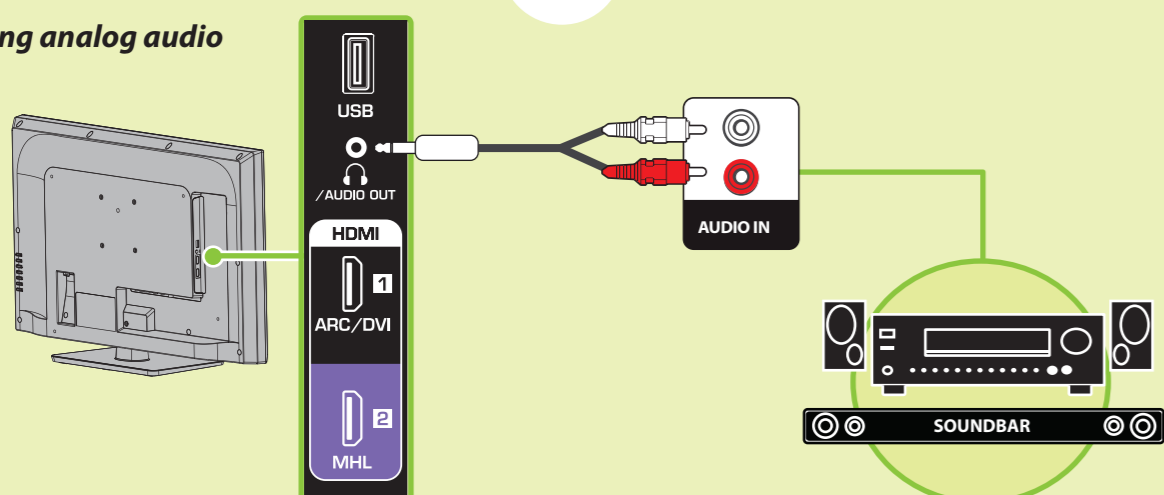

Note: Refer to the instructions that came with your speakers for more information.

Using your remote control

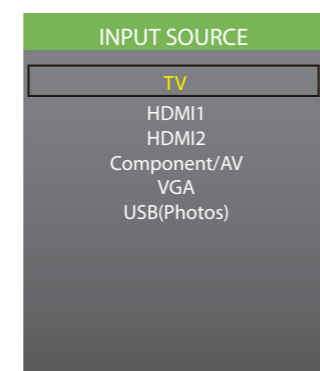

What are my screen-size options?

- NORMAL:** Original aspect ratio is preserved. Black bars are present if content is not widescreen (16:9).
- ZOOM:** Expands the image to fill the screen. The top and bottom of the image may be cropped.
- WIDE:** Displays content recorded in a 16:9 (wide-screen) aspect ratio.
- CINEMA:** Stretches the image at the edges, but keeps a clear image in the center.
- AUTO:** Automatically adjusts the image based on the screen size and the TV program. Select this option if you are uncertain which aspect ratio to choose. **Note:** Auto is only available when Auto Aspect Ratio in the CHANNELS menu is set to On.

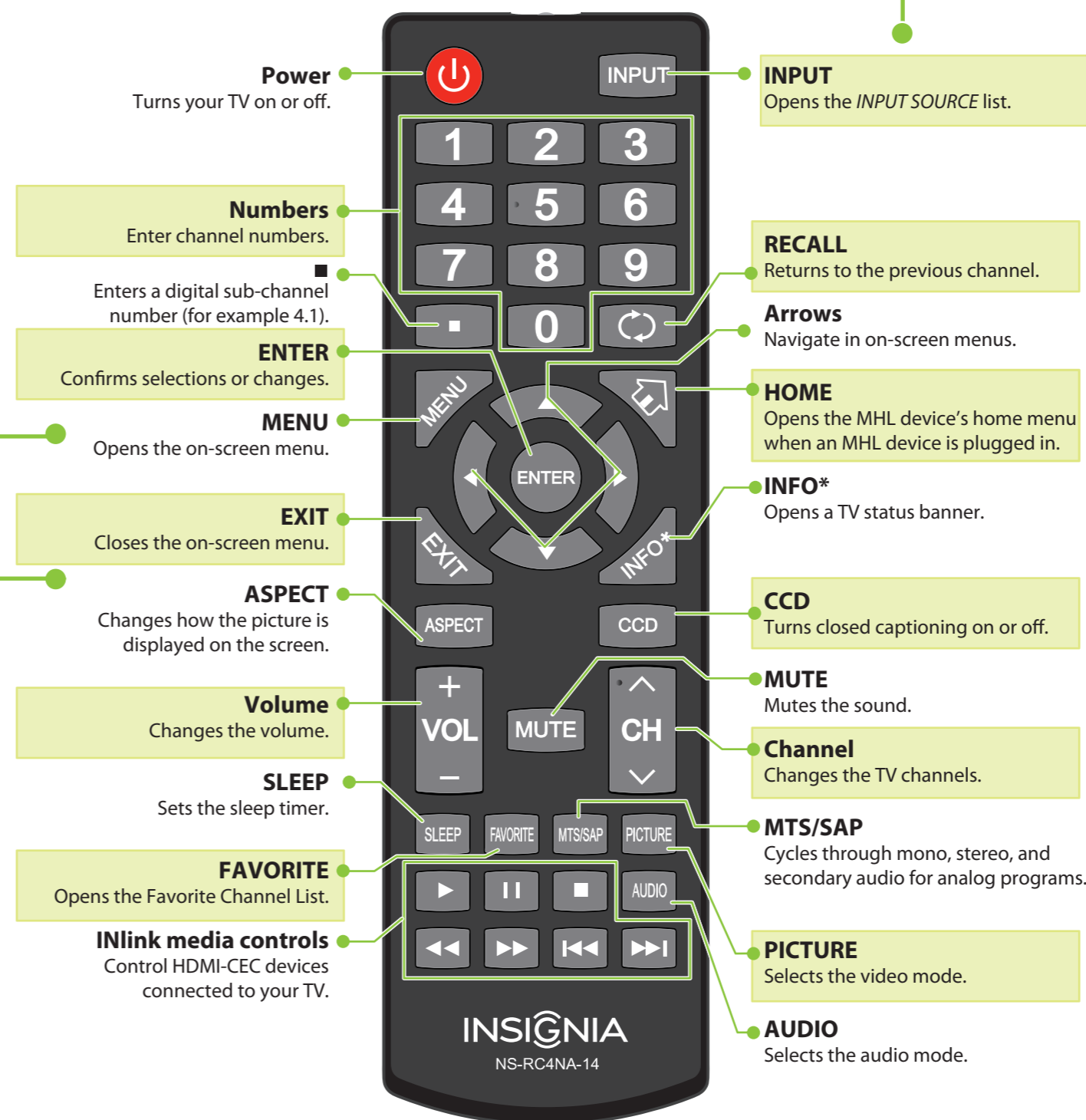

4 TURNING ON MY TV

When can I turn on my TV?

The best time to turn on your TV is after you have attached the TV stand or wall-mounted your TV and connected all devices.

- 1 Plug the power cord into the AC IN connector on the back of your TV.
- 2 Plug the other end of the cord into a power outlet.

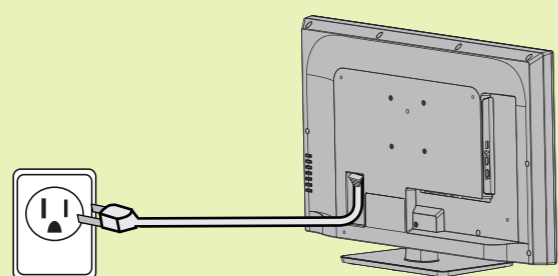

- 3 Install the remote control batteries.

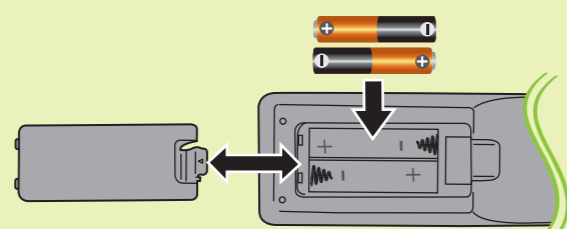

- 4 Press (power) on your remote control.
- 5 Follow the on-screen instructions.



I already have a universal remote control. How do I make it control this TV?

If you already have a universal remote control that you would like to program to work with your TV and don't want to use the included Insignia remote control, see the table for common codes.

UNIVERSAL REMOTE TV CODES	
CABLE BOX, SATELLITE BOX, OR OTHER SET-TOP BOX	
Cablevision	068, 069, 078, 096, 100, 164, 168, 229, 026
Charter	2002, 1204, 1423, 1517, 0171, 1963, 0463, 1463, 0842, 1326, 167, 415, 424, 450, 456, 461, 507, 523, 567, 577, 586
Comcast	10171, 11204, 11326, 11463, 11517, 11641, 11780, 11785, 11892, 11963, 12002
Cox	1326, 1463
Direct TV	10171, 11204, 11326, 11517, 11564, 11641, 11963, 12002
Dish Network	720
Time Warner	400, 450, 461, 456, 10463, 1463, 0463
Tivo	0091
Verizon	0198, 0490
UNIVERSAL REMOTE CONTROLS	
One for All	0054
Philips	0198, 0490
RCA	135
Sony	068, 069, 078, 096



For an up-to-date list of codes for other cable providers and universal remote brands, scan this QR code or visit www.insigniaproducts.com/remotecodes

One-year limited warranty
Visit www.insigniaproducts.com for details.

Need additional help?
See your online *User Guide*! This comprehensive guide includes everything from basic how-to steps to more advanced features. A copy of your *User Guide* is not provided in the box but is available online. Go to www.insigniaproducts.com, then click **Support & Service**. Enter your model number in the box under **Manual, Firmware, Drivers & Product Information**, then click ▶. Check out our **online community forum** at www.insigniaproducts.com for helpful information from other Insignia TV owners.

We're here for you
www.insigniaproducts.com
For customer service, call:
877-467-4289
(U.S./Canada markets)

INSIGNIA is a registered trademark of BBY Solutions, Inc. Registered in some countries. Distributed by Best Buy Purchasing, LLC, 7601 Penn Ave South, Richfield, MN 55423 U.S.A.

©2013 BBY Solutions, Inc. All Rights Reserved 1-877-467-4289 www.insigniaproducts.com